

Data Sheet

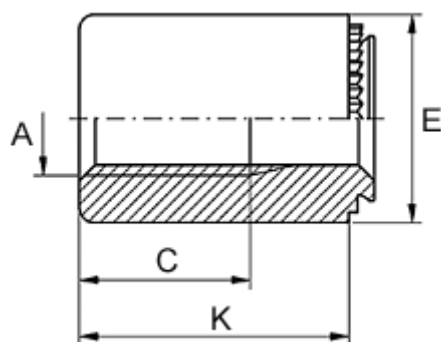

Article number: 12510800240500
Description: KLEE-coil 510 800 240.500
M4 Stainless 1.4305

Measures



Female thread A	= M4
Height K	= 10
Min distance to edge	= 4.0
Outer diameter E	= 8
Plate thickness	= 1.5 to 2.3
Recommended bore diameter +0.05	= 5.00
Thread length	= 8.0